







Legend	Model
	VES 390/WP/E
	VES 390/WP/EL
	VES 390/WP/ER
	VES 390/WP/RM
	VES 390/WP/RML
	VES 390/WP/RMR



### Specifications :

Polycarbonate Housing & Diffuser

### Mounting Method :

Wall Mounted For Outdoor Area  
(Above Doors / Entrances & Exits)

### Add-On / Optional :

Mounting Bracket

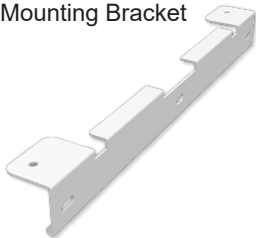

### Test Standard :

IEC 60598-2-22:2021  
IEC 61347-2-7:2021  
SS 563-1:2010/A1:2017  
SS 563-2:2010/A2:2017

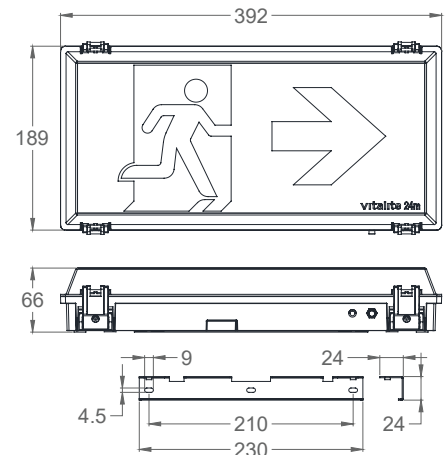

Mains Supply	220 – 240V 50/60Hz	Rating	0.01A / 2.9W / 0.8 PF
Mode of Operation	Maintained	Classification	Class II
Lamp	LED 2835 (4 PCS)	Degree of Protection	IP 65
Battery	Ni-Cd AA 3.6V 900mAh	Max. Operating Temperature (ta)	40°C
Emergency Duration	2 Hours	Recommended Mounting Height	Min. 2.3m
Recharge Period	15 Hours	Weight	0.85 KG

Packing : 10 Sets Per Carton Box  
Outer Carton Box : L460 X W400 X H430 mm (11.80 KG)  
Inner Carton Box : L398 X W72 X H202 mm (1.03 KG)